

1 Print the PDF.

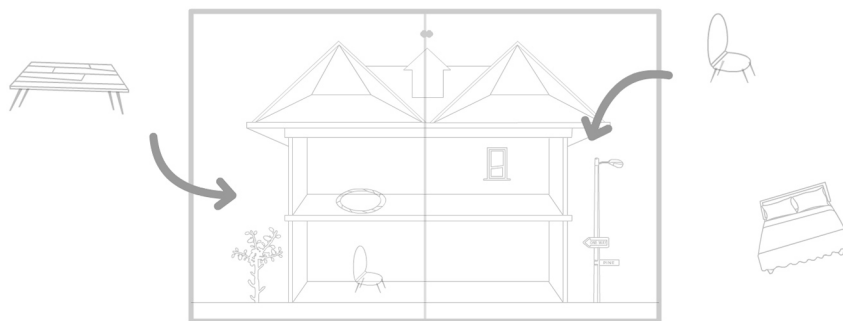

2 Cut and place the furniture in the house of Nola or in your drawing home



3 You can crop the Dreamsons or draw and cut the inhabitants of your house

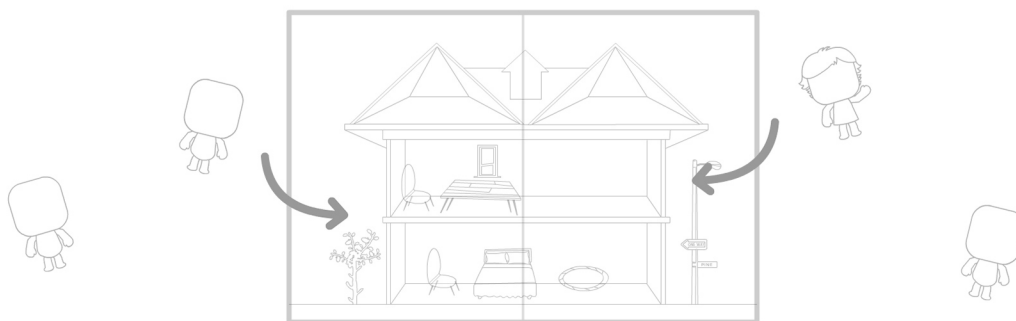

YOU NEED...



Paper



Printer



Scissors



Crayons



Pencil

The Dreamsons

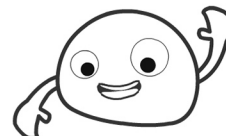
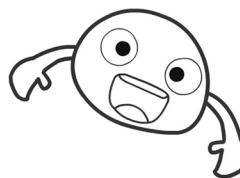
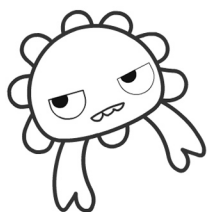
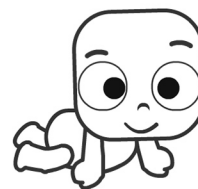
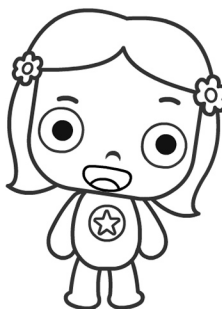

Your family

Draw your family faces

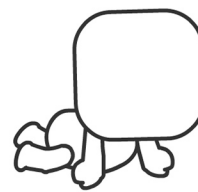
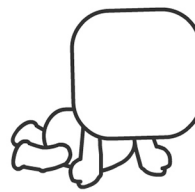
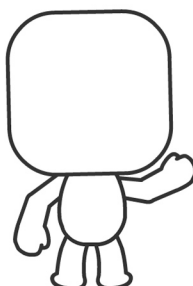
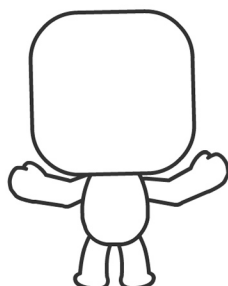
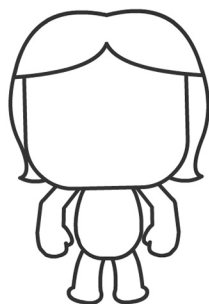
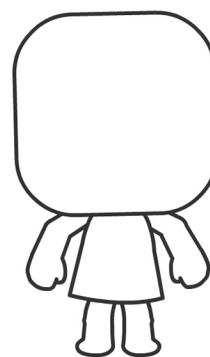
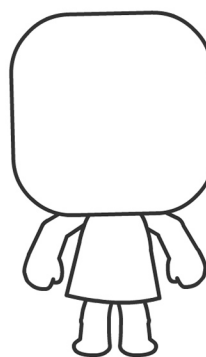
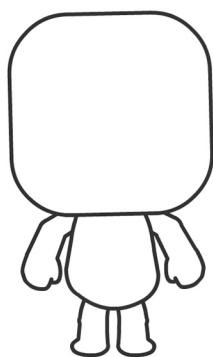
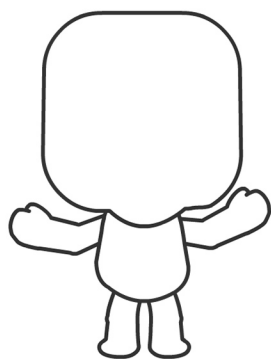
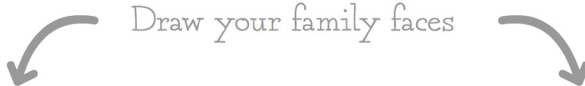

Desks

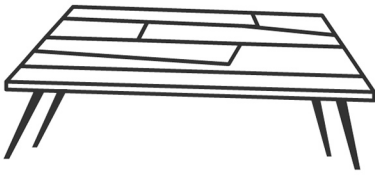

Shelves & side tables

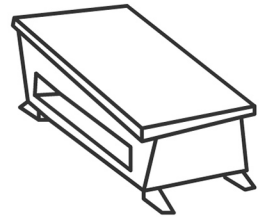
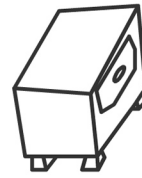
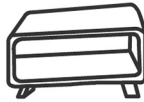

Windows

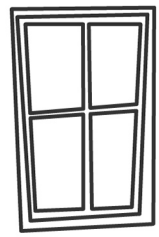
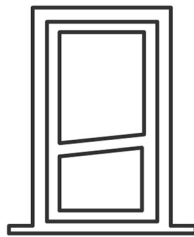
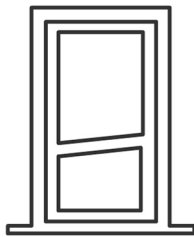

Carpets

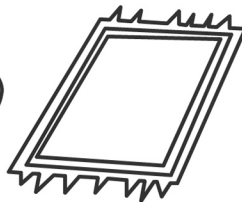
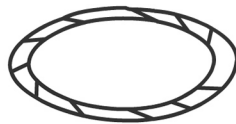

Frames



Chairs



Lamps & clock



Closets

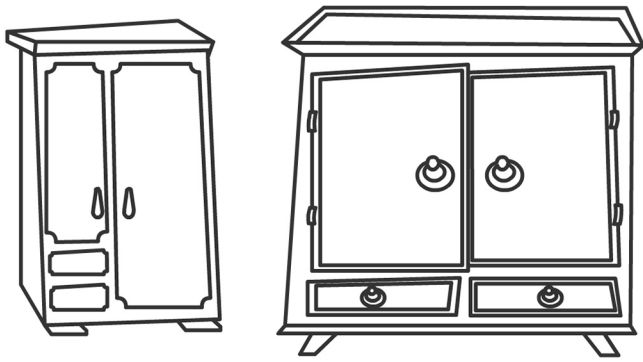

Storage

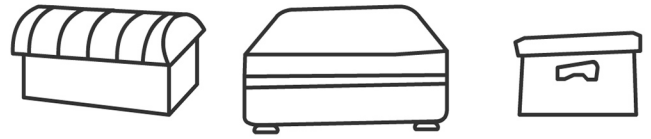

Beds

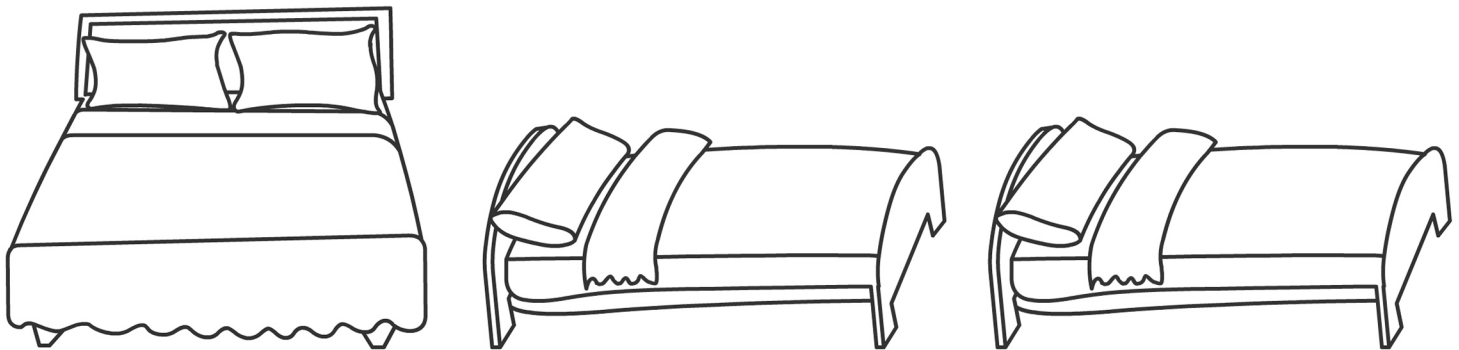

Bath

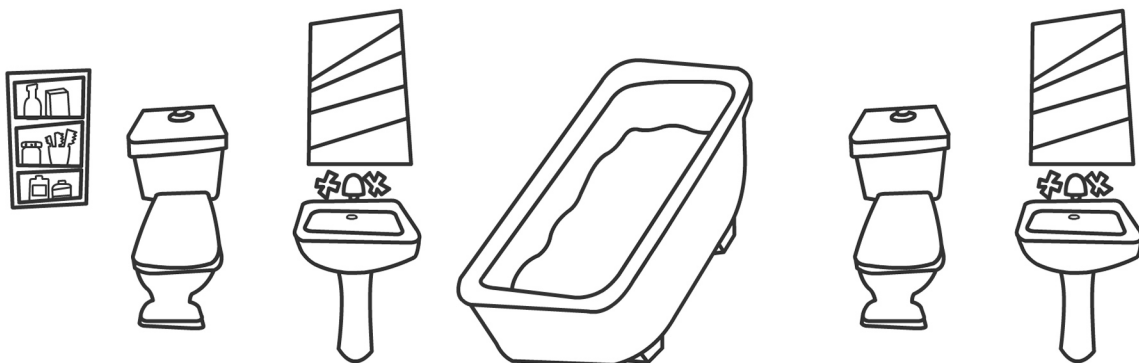

Kitchen

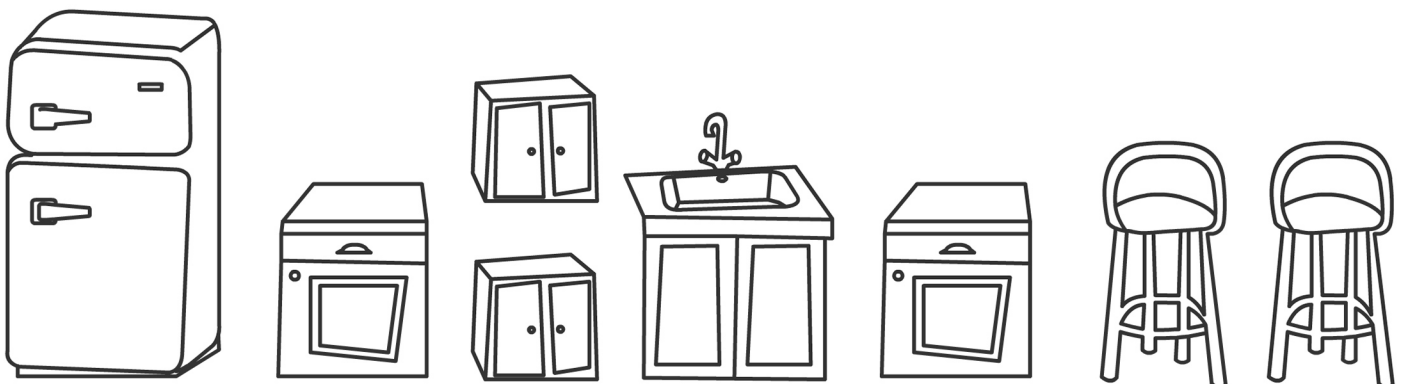

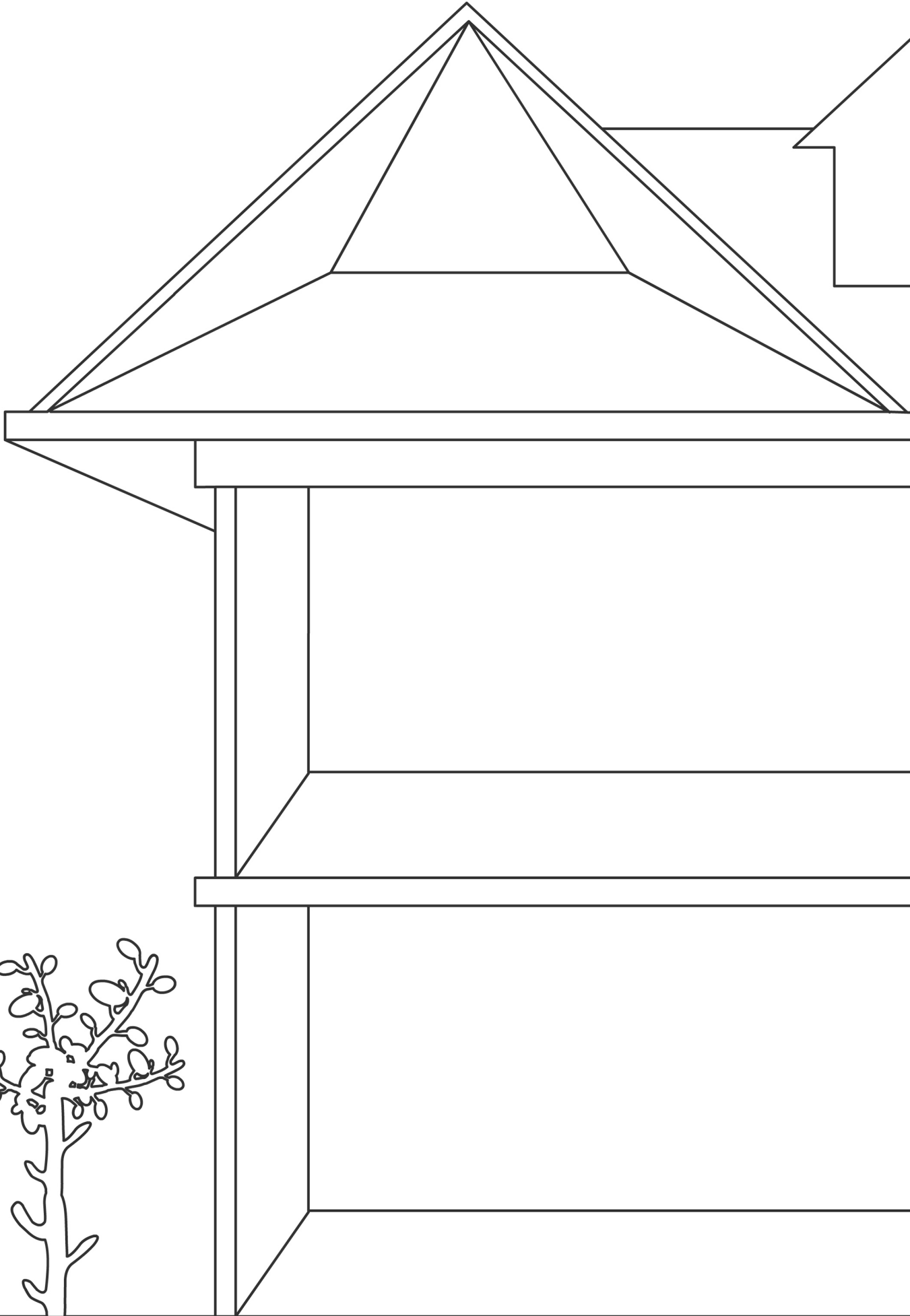

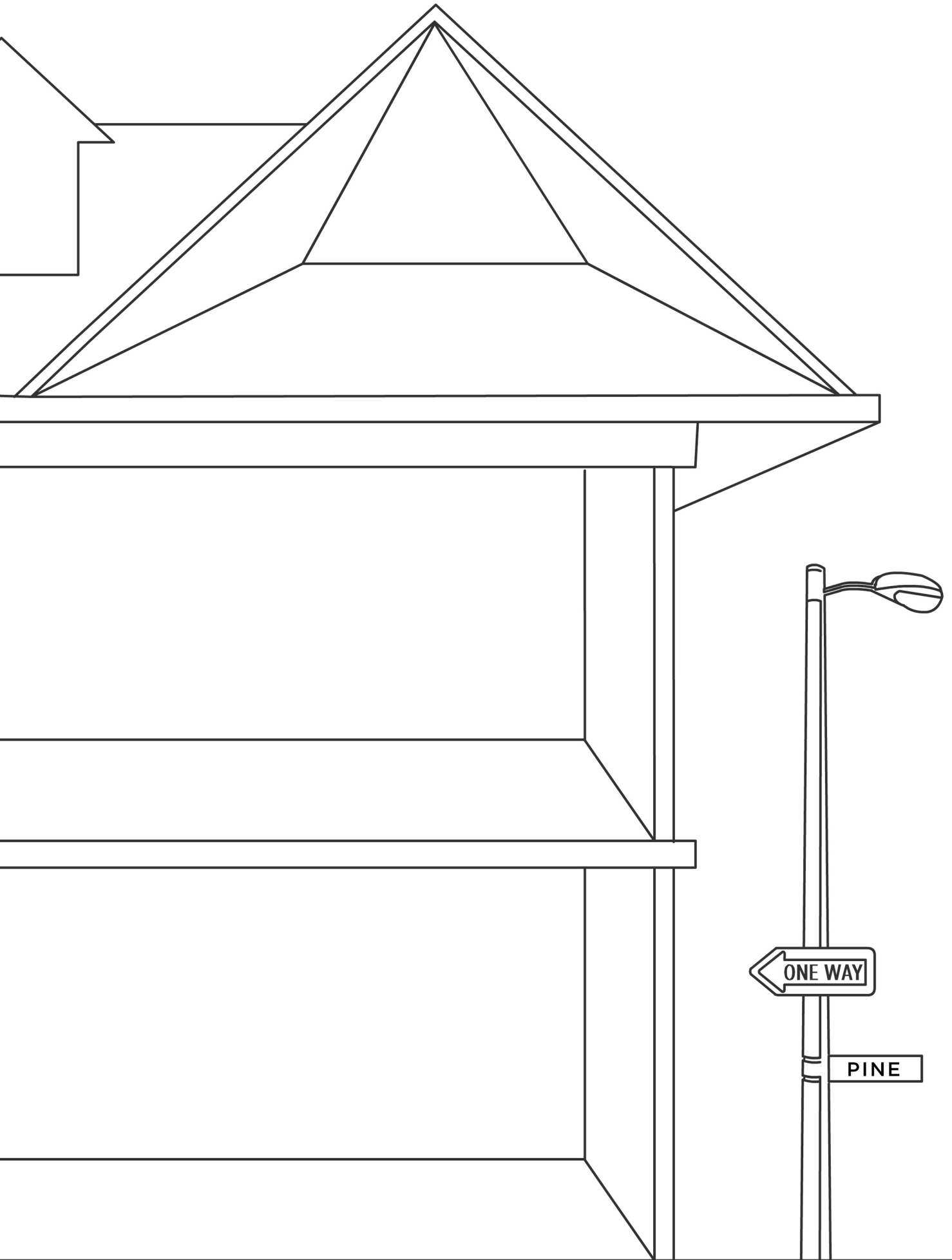

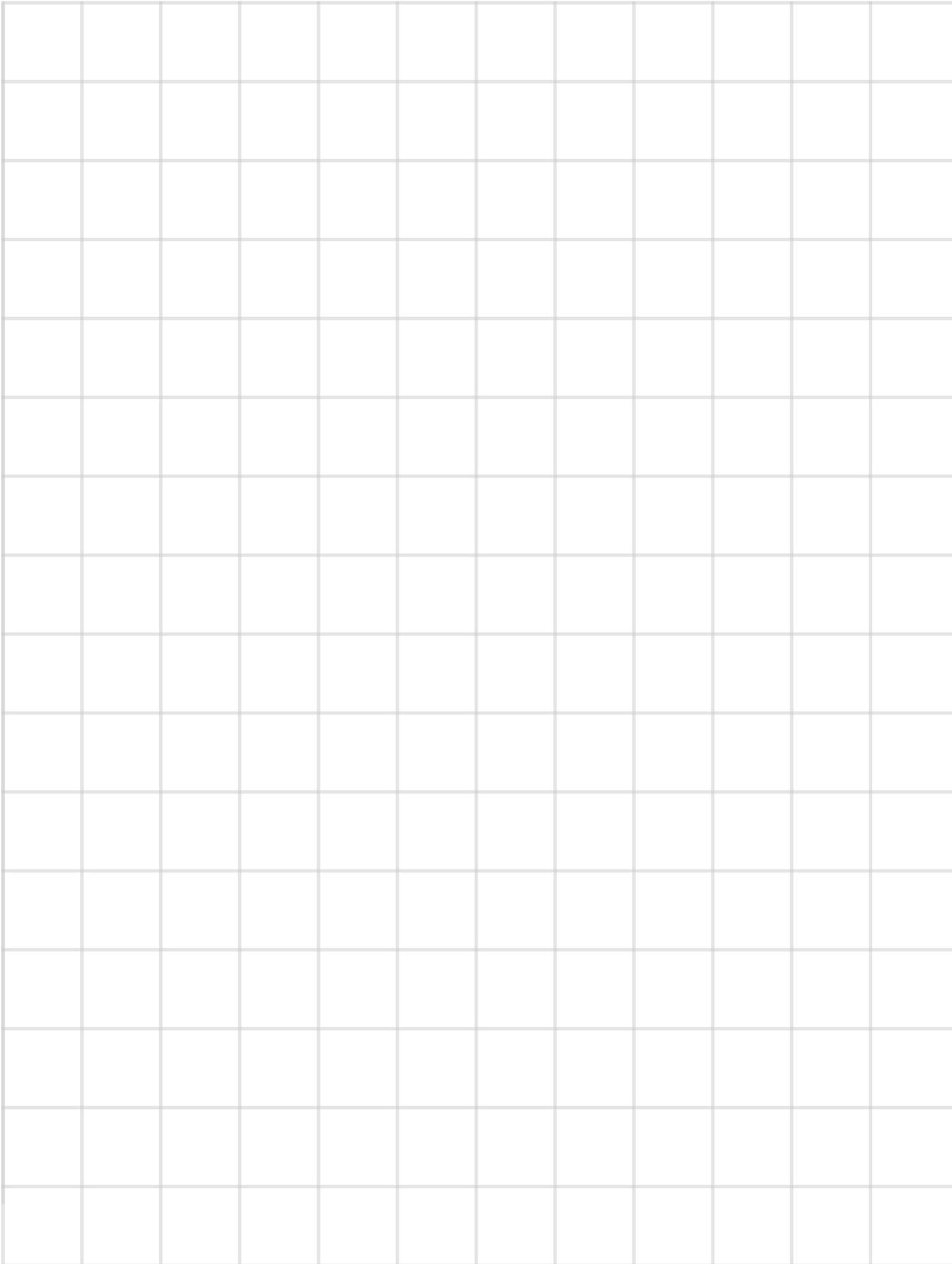



Your Houses / Draw your house

